

# CM Series of Counter/Timer Instruction Manual

## Features:



- ◎ Single line of 4, 5, 6, digit LED display.
- ◎ Different size for option: 48X48mm, 72X72mm, 48Hx96W
- ◎ Thumb switch setting value
- ◎ Four kinds of input mode: A, B, C, D. (Mode D can be used with encoders.)
- ◎ Two output channels (relay or transistor): AL1, AL2. 12 types of output mode: F, N, R, C, K1, K2, P, Q, A, D, H, L.
- ◎ Power fail memory function
- ◎ Key and thumb switch protection function.
- ◎ Key and terminal connection reset function.
- ◎ Timer pause function.
- ◎ 8 types of timer function. Algorithm or Hex for option.
- ◎ Timer double relay. Output unit free set for H (hour), M (minute), S (second).
- ◎ High anti-interference

## 1. Ordering code

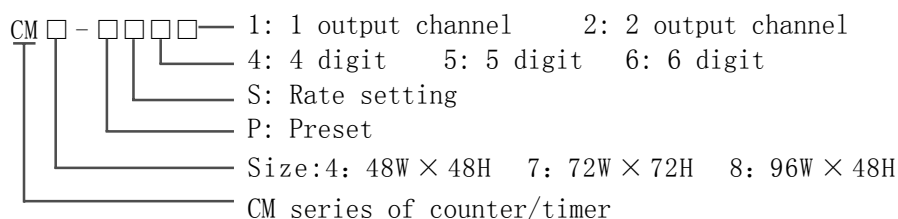

MODE	SIZE (mm)	DIGIT	STAGE	RELAY	SSR	POWER
CM4-PS41	8W × 48H	4 位	Simple	AL2	Special order	AC 90~250V
CM7-PS41	72W × 72H	4 位	单段	AL2	Special order	AC 110/220V
CM7-PS42	72W × 72H	4 位	两段	AL1、AL2	Special order	AC 110/220V
CM7-PS61	72W × 72H	6 位	单段	AL2	Special order	AC 110/220V
CM7-PS62	72W × 72H	6 位	两段	AL1、AL2	Special order	AC 110/220V
CM8-PS42	96W × 48H	4 位	两段	AL1、AL2	Special order	AC 110/220V
CM8-PS61	96W × 48H	6 位	单段	AL2	Special order	AC 110/220V

\* Note: Please let us know your special demand in case the instrument still cannot meet your request. We will try our best to satisfy you.

## 2. Parameters

Power supply	CM7、CM8: 220VAC ± 15% or 110VAC ± 15% CM4: 90~250VAC
Consumption	< 5W
Output mode	Relay and transistor output are synchronous
Relay output capacity	250VAC/3A 或 30VDC/5A
Transistor output capacity	30VDC/50mA
Auxiliary output power supply	CM7、CM8: 12VDC ± 10% 100mA max CM4: DC 12VDC ± 10% 50mA max
Insulation resistance	≥ 100M Ω
Anti-interference	Power: ± 2000V Input: ± 500V
Anti-shock	10~55Hz; 0.75mm
Parameter reserve time	10 years
Temperature	0~50℃
Humidity	35~85%RH

◆ Counter Parameters

Input signal	脉冲信号：方波、正弦波、三角波； $3V \leq H \leq 30V$ $0 \leq L \leq 1V$
Spring edge	up
Input impedance	$\geq 10K \Omega$
Counter speed	3000CPS
Counter range	-1999~9999 (4 digit display reserve 3 digit decimal point) -199999~999999 (6 digit display reserve 4 digit decimal point)
Output delay	0.01S~99.99H (4 digit display) 0.01S~9999.99H (6 digit display)
Rate setting range	0.001~9999 (4 digit display) 0.00001~9999.99 (6 digit display)

◆ Timer Parameters

Accuracy	$\pm 0.01\%$
Reset time	$< 50ms$
Time of power supply action	$< 300ms$
Timer range	0.01S~999.9H (4 digit display), 0.01S~99999.9H (6 digit display)
Delay range	0.01S~99.99H (4 digit display), 0.01S~9999.99H (6 digit display)

### 3. Configuration and connection

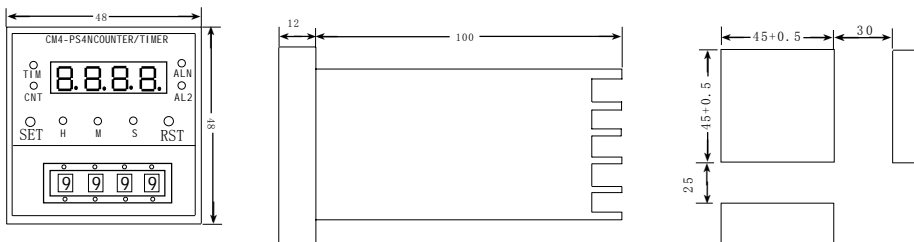

CM4

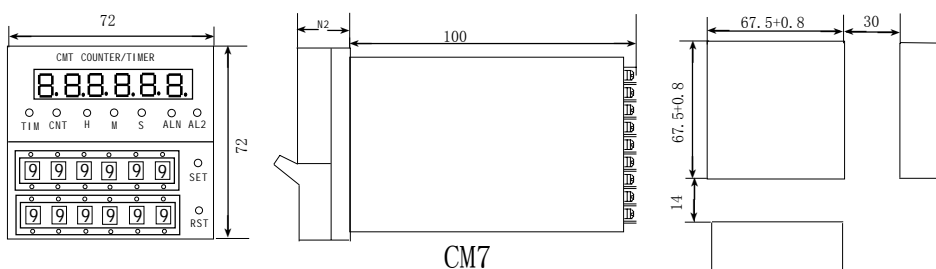

CM7

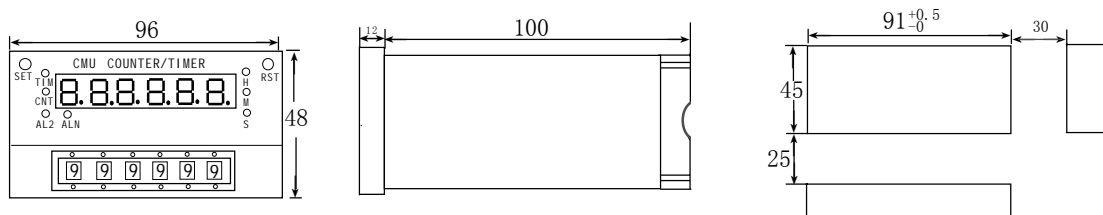

CM8

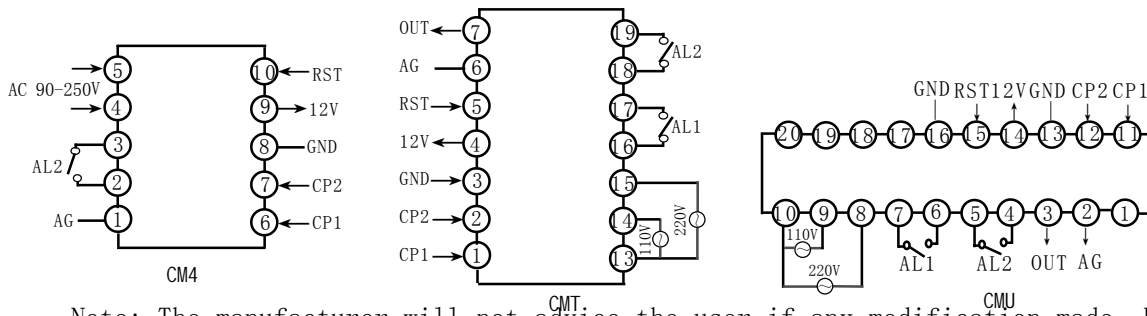

Note: The manufacturer will not advise the user if any modification made. Please connect as the terminal connection label show on the surface of the plastic box of the counter/timer.

#### 4. Use and Operation

- 1). The instrument should be check if the connections are all correct before supply power.
- 2). There are 2 operating keys that use with up-line thumb switch can modify the parameters of the unit.  
 SET: Set and confirm key. Press it for 5 seconds to enter the estate of setting parameters.  
 RST: Reset and select key. Press it can reset the measuring value and output value. In the estate of setting, press it can select the parameters.

#### 3). 仪表设定参数操作流程

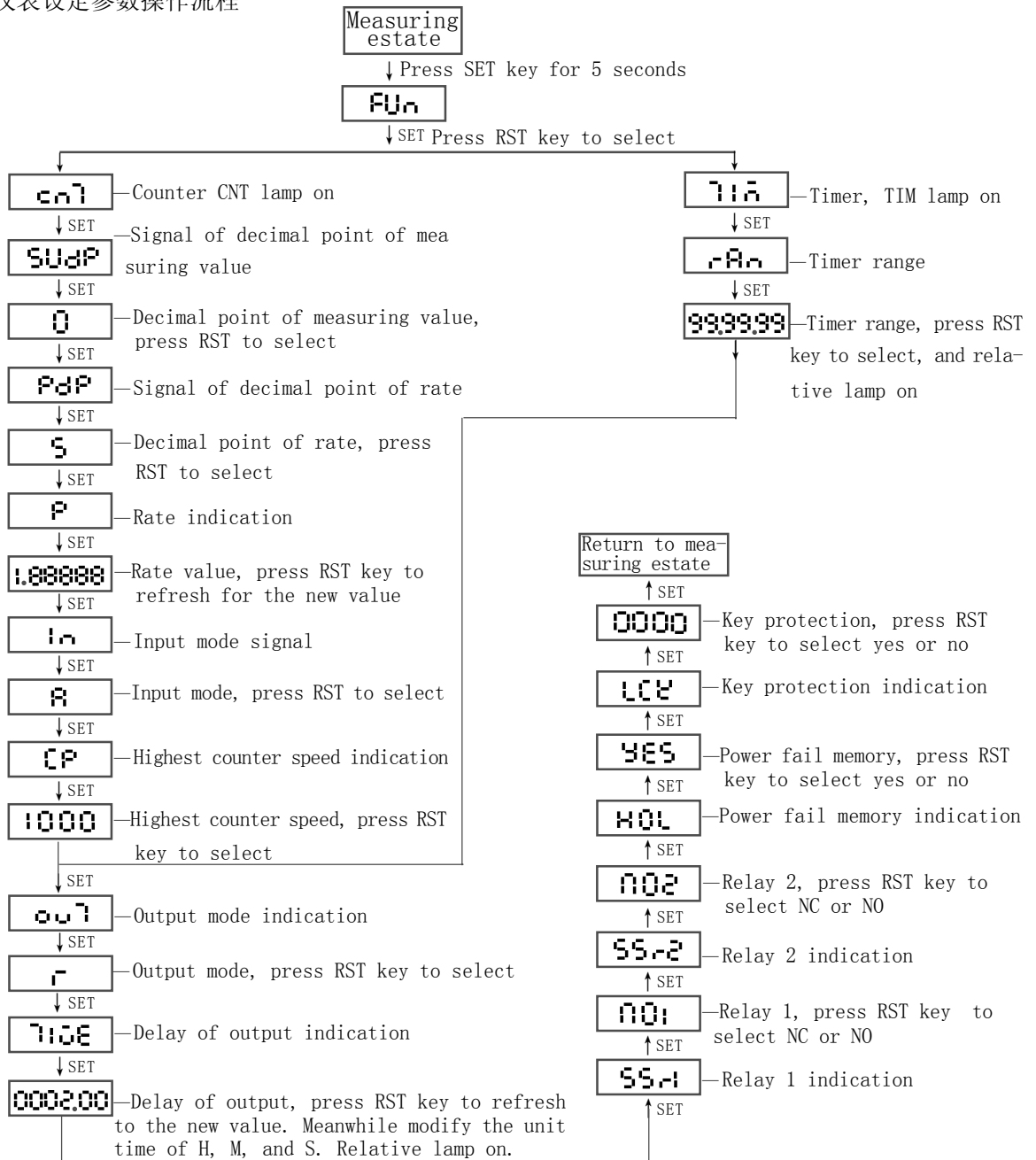

注：具体参数含义及设定方法参看附表1

## 5. Additional notes

- 1). In the estate of measuring, short RST connection diagram or press RST key will cause the display value and output reset.
- 2). The width of reset signal RST and pause signal PAUSE must more than 50ms. In case the instrument is used for timer, CP2 can be the same function of PAUSE.
- 3). The transistor is of collector open output. If the user want +12V voltage output, it should be mentioned when order. Transistor output and the relay output is synchronous. CM4-PS41 is not for transistor output. It should be mention when order if you want transistor output.
- 4). In case counter input mode D, it can be used with encoder.
- 5). The input wire should not to too long, we suggest use the shielded wire. The instrument should not used under the circumstance of humidity>90% and strong acidity.
- 6). When the instrument displays 掏rr0 please check the value to see if SV2>SV1>P>0.
- 7). After the user set the parameters well and want to return to the measuring estate, you had better press RST key to reset the instrument.
- 8). In case the instrument is transistor collector open output, output low voltage diagram is AG and high voltage diagram is OUT. AG should not short with OUT, otherwise the instrument may be burned. We suggest using the external power supply but not 12V in the instrument for the transistor. To not interfere the input signal.
- 9). In case output is C mode, and if the delay of output>next counter/timer cycle, the instrument can not reset by itself.

## 6. Form 1: Parameter setting

Code	Parameter	Meaning	Specification	Range	Factory setting
1	FUN	Function selecting	Press RST to select CNT: counter TIM: timer	CNT、TIM	CNT
2	SUOP	Decimal point	Press RST to select 0: non            1: 1 decimal 2: 2 decimal    3: 3 decimal 4: 4 decimal    5: 5 decimal	0、1、2、 3、4、5	0
3	PDp	Rate decimal point	Press RST to select 2: 2 decimal    3: 3 decimal 4: 4 decimal    5: 5 decimal	2、3、4、 5	5
4	P	Rate	Set the value by the up-line LED then press RST to refresh. If not press RST to refresh, the instrument take it as previous value.	0.001~9999 (4位显示) 0.00001~9999.99 (6位显示)	1.00000
5	IN	Input mode	Press RST to select	A、B、C、 D	A
6	CP	Highest counter speed	Press RST to select	5CPS、30CPS、 200CPS、1KCPS、 3KCPS	1KCPS
7	rAn	Timer range	Press RST to select 5(6) digit display (9)999.99+ S lamp on, range: algorism 0.01S-(9)999.99S (9)999.99+ M lamp on, range: algorism 0.01M-(9)999.99M (9)999.99+ H lamp on, range: algorism 0.01H-(9)999.99H (9)9999.9+ M lamp on, range: algorism 0.1M-(9)9999.9M (9)9999.9+ H lamp on, range: algorism 0.1M-(9)9999.9H (9)9.59.59+H, M, S lamps on, range: 1S-(9)9H59M59S (9)9.59.99+M, S lamps on, range: 0.01S-(9)9M59S99mS (9)999.59+H, M lamps on, range: 1M-(9)999H59M 4 digit display 99.99+ S lamp on, range: algorism 0.01S-99.99S 99.99+ M lamp on, range: algorism 0.01M-99.99M 99.99+ H lamp on, range: algorism 0.01H-99.99H 999.9+ M lamp on, range: algorism 0.1M-999.9M 999.9+ H lamp on, range: algorism 0.1M-999.9H 99.59+M, S lamps on, range: 1S-99M59S 999.9+S lamp on, range: algorism 0.1S-999.9S 99.59+H, M lamps on, range: 1M-99H59M	8种	99H59M59S  H、M、S灯亮

Code	Parameter	Meaning	Specification	Range	Factory setting
8	OUT	Output mode	Press RST to select. Please refer form 3	F、N、R、C、K1、K2、P、Q、A、D、H、L	R
9	TIME	Delay of output	Set the value by the up-line LED, then press RST to refresh. The unit of the new value refresh too.	0.01S~99.99H	2.00S
10	SS-1	Relay 1 (AL1)	Press RST to select the output mode of the relay 1. NO1: relay 1 NO NC1: relay 1 NC The relay will act if it change to NO/NC	NO1、NC1	NO1
11	SS-2	Relay 2 (AL2)	Press RST to select the output mode of the relay 2. NO2: relay 2 NO NC2: relay 2 NC The relay will act if it change to NO/NC	NO2、NC2	NO2
12	HOL	Power fail memory	Press RST to select YES or NO <b>YES</b> : 仪表有停电记忆功能; <b>NO</b> : 仪表无停电记忆功能。	YES、NO	YES
13	LOC	Key protection	Press RST to select: 0000: No key protection 1111: Protect thumbn switch, key opened, press RST to refresh if setting thumbn value. 2222: Protect thumbn switch and RST key. Thumbn and RST key will lost function. ( Only applied to output mode C, R, P, Q. The instrument will be in automatic control 3333: Factory setting only. User not available.	0000 1111 2222 3333	0000

## 7. Form 2 The relationship between input mode and the value

Mode	up	Specifications
A		CP2 low voltage allow CP1 counter. CP2 high voltage not allow CP1 counter.
B		CP2 low voltage, CP1 increase counter. CP2 high voltage, CP1 decrease counter.
C		CP1 increase CP2 decrease Display value=CP1-CP2
D		CP2 later than CP1, CP2 increase counter. CP2 before CP1, CP2 decrease counter.

## 8. Form 3 The relationship between display value and output mode.

		Input mode		计数到达设定值后的动作
		计数器A方式及定时器	计数器B、C、D方式	
输出方式	F			The display value will continue decrease/increase till reset input
	N			Output and display value will continue till reset input
	R			When the display value and the delay of output reaches the setting value, it will return to the start estate.
	C			The display value will turn back to the start estate, output will delay to the setting value and turn back to the start estate. AL1 will continue output, and it will stop when reaches delay time of AL2.
	K1			The display value continues, AL1 will continue output and it will stop when reaches delay time of AL2.
	K2			The display value continues, till to reset and return back to the start estate

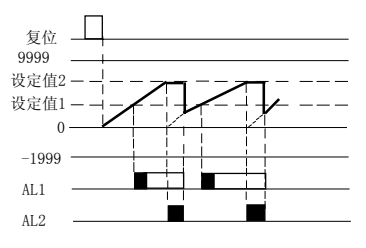
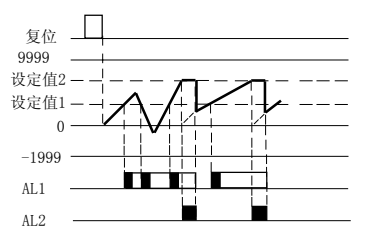
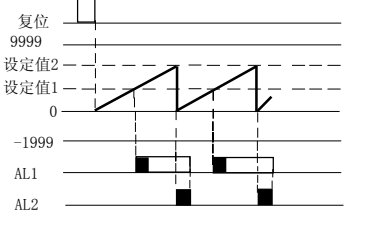
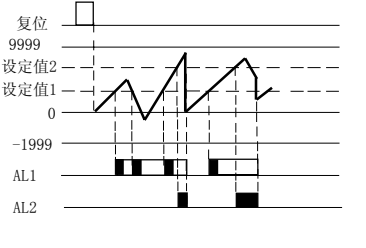
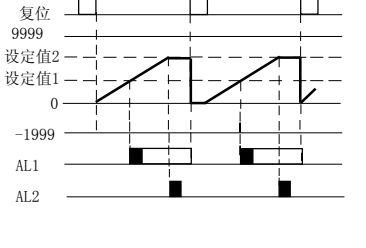
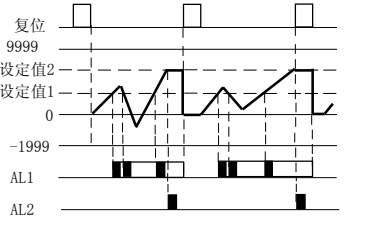
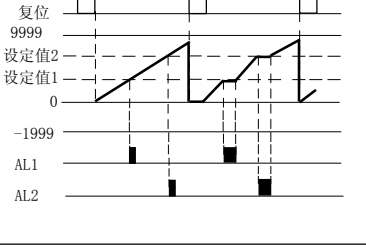
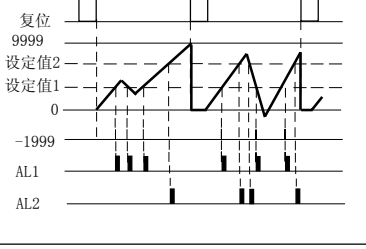
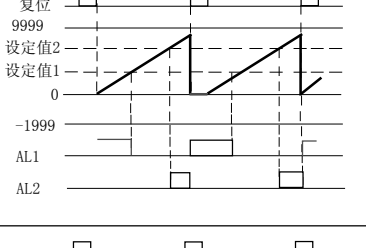
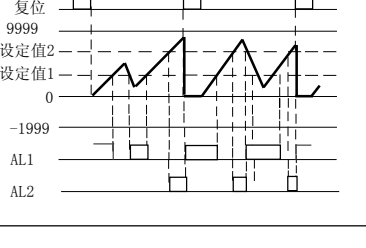
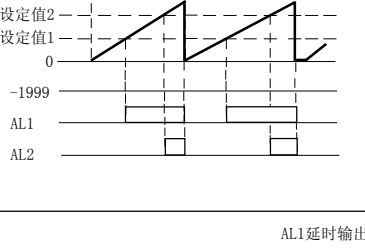
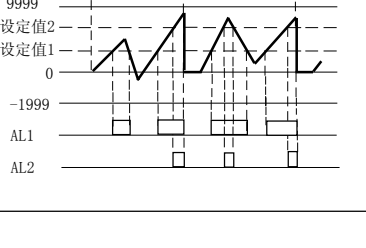
		输入方式		计数到达设定值后的动作
		计数器A方式及定时器	计数器B、C、D方式	
输出方式	P			The display value continues delay output, displays next cycle. AL1 will continue output and it will stop when reaches delay time of AL2.
	Q			The display value continues to increase/decrease during the course of delay output. AL1 will continue output and it will stop when reaches delay time of AL2.
	A			The display value and AL1 output continue till to reset input. AL2 delay output will return back to start estate.
	D			It will output only the display value and the setting value is the same.
	L			The display value continues till external reset: AL1 output maintain when (display value < setting value1) AL2 output maintain when (display value > setting value2)
	H			The display value continues till external reset: AL1 output maintain when (display value > setting value1) AL2 output maintain when (display value > setting value2)

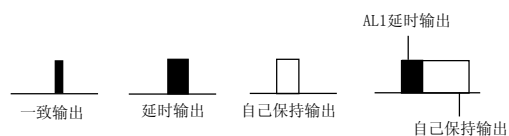

延时输出时间: 0.01S-9999.99H可变(6位显示)  
0.01S-99.99H 可变(4位显示)

## 9. Examples of use how to connect a proximity sensor to the instrument.

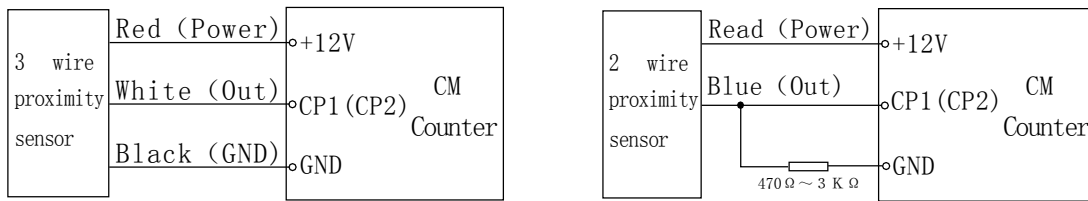

## 10. Example for use with proximity sensor and encoder

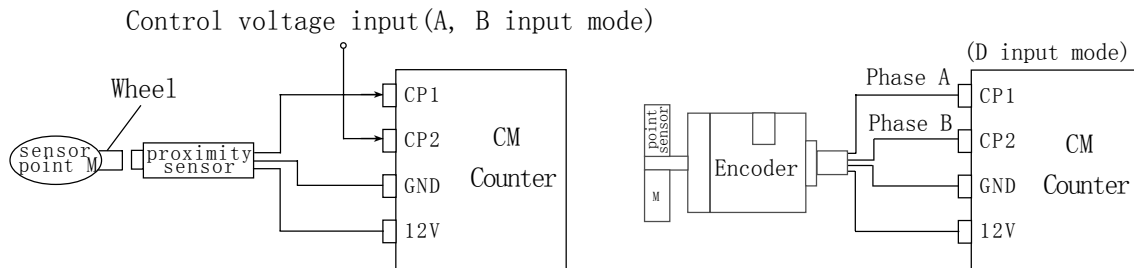

Note: B input mode (decrease or increase).  
 CP2 is low voltage, CP1 increase counter.  
 CP2 is high voltage, CP1 decrease counter.  
 (The user should short CP2 and +12V diagram in case there is not high voltage.)

Note: If the encoder phase A and B is collector open output, then a resistance between CP1 and CP2 should be added. The resistance value probably be 5.1K

## 11. Malfunction Elimination

- 1). The instrument doesn't counter
  - ★ Check if the diagram connection is correct.
  - ★ Check if the input signal, voltage, frequency of the sensor is correct.
  - ★ Check if the input mode, counter speed is of conformity with the instruction.
  - ★ Check if the rate P is large enough.
  - ★ Check if output signal is voltage. The input resistance should be 17K. If the input signal is on/off, the signal should be added a resistance 5.1K to +12V diagram.
- 2). Can not set the Setting Value or can not reset by press RST key.
  - ★ Check the LCK key protecting menu to see if the RST key has been locked.
  - ★ Set LCK=0000, it means all keys opened for operation. LCK=3333 is only used by the factory, the user can not set.
- 3). With (without) power fail memory
  - Check parameter HOL.
  - ¡If it is YES, means with power fail memory.
  - ¡If it is NO, means without power fail memory.
- 4). The instrument can not work after setting some parameters and values.
  - ¡Out of the parameter setting menu or modify some values, and then press RST key to reset this parameters. (LCK can not be 2222, or RST key will not function.)

 TOKY ELECTRICAL CO., LTD 东崎仪表 杰出品牌	Hongkong (FAX) : 00852-26146109	Mainland (FAX) : 0760-2226859
	(Add): NO.1 Gaosha Road Dongsheng Town Zhongshan City Guangdong Province	
	China	
	http:// www . toky . com . cn	
	E-mail: xs@toky.com.cn	