

# AXE MICROPROCESS PANEL CONTROLLER METER

MM2 Series

## Features

Measuring DCA/DCV/ACA/ACV/Potentiometer/Pt-100/ Transmitter/Load Cell/Resistor...etc Accuracy 0.1% F.S. ±1 digit Display range -19999~19999 can be modified Decimal point can be modified Display value can Auto-zero and Hold function Display value can Max. hold function 4 Alarm function Display average can be modified(1~99)	15BIT DAC analog output can be modified,0~10V /4~20mA by inside switch jumper RS485communication interface,Protocol MODBUS RTU MODE BAUD RATE:19200/9600/4800/2400 0.56" highlight display Man-machine interface ,easy to operate EEPROM Saving,data safekeeping about 10 years Modified inside parameter,must have pass code
---	--

## Name Of Parts

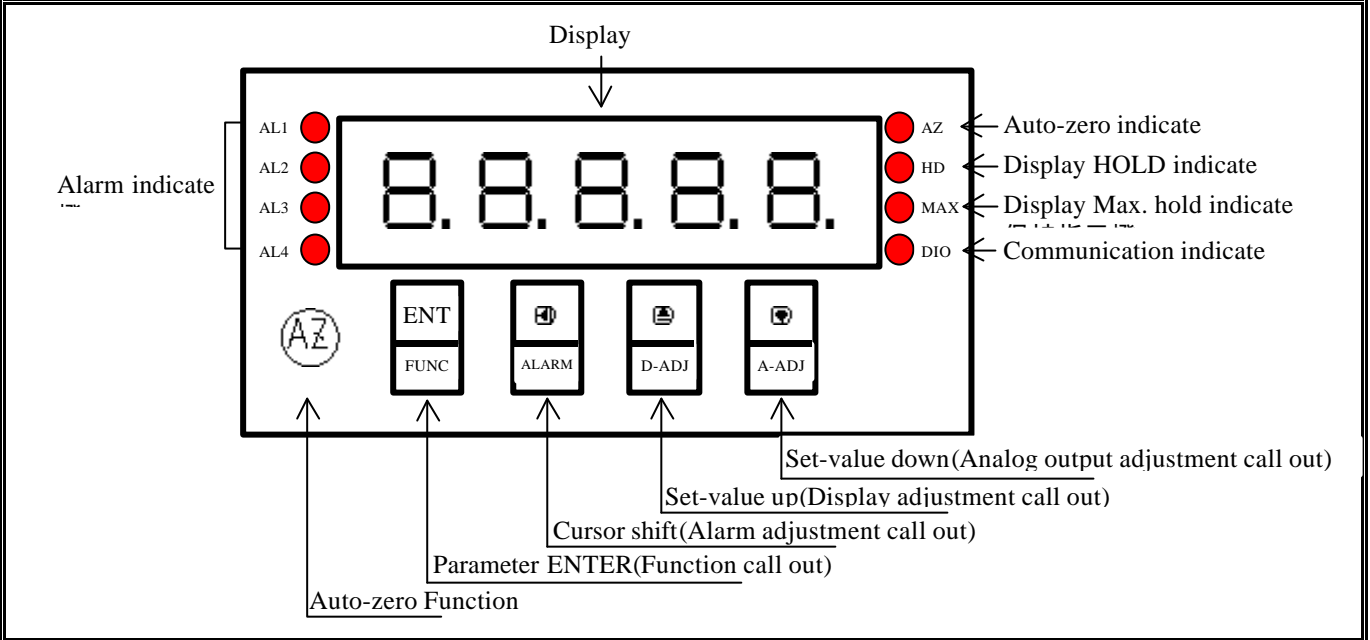

## Alarm Function Diagram

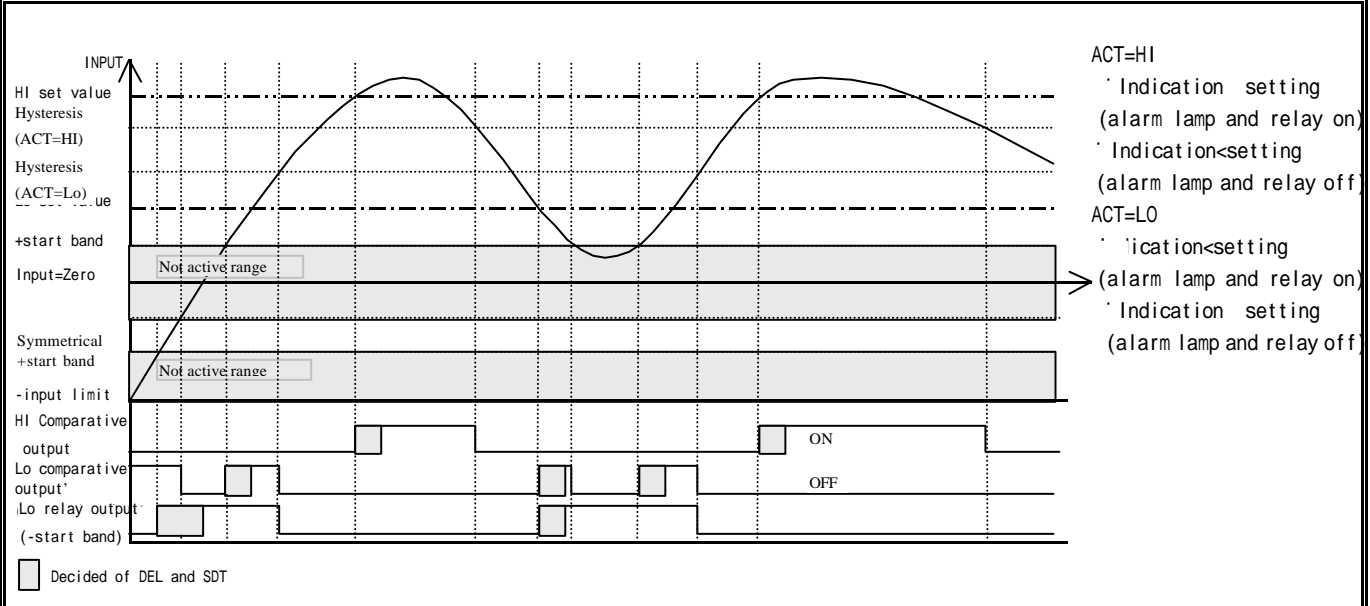

## Analog Output Function Jumper Table

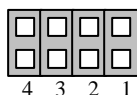



















Position 1&3 ON: DC 4~20 mA OUTPUT

Position 2&4 ON: DC 0~10V OUTPUT

Key Introduce		Operation Manual	
Key Function		1.In normal display,The key function is call out setting group 2.In parameter setting page,The key function is data Enter , and goto next page	
Key Function		1.In normal display,The key function is call out alarm value setting page 2.Into parameter setting page,the parameter mark&data is alternate display,If need modify data can press shift key into setting procedure,The display is lock parameter data,this time must let off key about 0.2 sec,press again,the cursor(twinkle express)is cycle moving left. (Key Response about 0.2 sec)	
Key Function		1.In normal display,The key function is call out adjustment display value (DZERO&DSPAN)page 2.Into parameter setting page,the parameter mark&data is alternate display,If need modify data can press up key into setting procedure,The display is lock parameter data,this time must let off key about 0.2 sec,press again,the parameter data will increment. (Key Response about 0.2 sec)	
Key Function		1.In normal display,The key function is call out adjustment analog output (AZERO&ASpan)page 2.Into parameter setting page,the parameter mark&data is alternate display,If need modify data can press down key into setting procedure,The display is lock parameter data,this time must let off key about 0.2 sec,press again the parameter data will decrement. (Key Response about 0.2 sec)	
&  Key Function		In setting group or setting page press  &  key return normal display,but if in setting page the modify data will be lost	
No Key in anything		In setting group or setting page no key in anything about 2 minutes,return normal display,but if in Setting page the modify data will be lost	
Step	Parameter Mark Description	Parameter Mark	Operation Manual
1	Normal display	1 2 3 4 5	Press /FUNC key into P.COD setting page
2	P.COD(Pass code input page)	P C o d	1.Key in 5 digit pass code with  or  or  key 2.Press  key, the pass code is right into setting group , otherwise return normal display
		□ □ □ □ □	
3	SYS(System setting group)	S Y S	1. Select setting group with  key 2. Press  key into setting page of selection setting group
	ROP(Alarm setting group)	r o P	
	AOP(Analog output setting group)	A o P	
	DOP(Communication setting group)	d o P	
4	SYS(System setting group)	S Y S	Press  key decide SYS setting group , press  key into DP setting page
4-1	DP(Decimal Point) Default=0	d P □	1. Decide decimal point position with  or  key (0 to 4) 2. Press  key enter data and into DSPL setting page
4-2	DSPL(Display Low Scale) Default=0	d S P L □ □ □ □ □	1.Decide display low scale with  &  &  key (-19999~19999) 2.Press  key enter data and into DSPH setting page
4-3	DSPH(Display High Scale) Default=19999	d S P H 1 9 9 9 9	1.Decide display high scale with  &  &  key (-19999~19999) 2.Press  key enter data and into AVG setting page
4-4	AVG (Average) Default=1	A v g □ □ □ □ □	1.Decide display Average times with  &  &  key (1~99) 2.Press  key enter data and into LCUT setting page
4-5	LCUT (Low Cut) Default=0	L C U T □ □ □ □ □	1.Decide display low cut with  &  &  key (0~99) 2.Press  key enter data and into CODE setting page
4-6	CODE(Pass Code) Default=0	C o d e □ □ □ □ □	1.Decide Pass code with  &  &  key (0~19999) 2.Press  key enter data and into LOCK setting page
4-7	LOCK(Panel Lock) Default=NO	L o c k n o	1.Decide panel lock with  or  key (NO or YES) 2.Press  key enter data and return SYS setting group
5	ROP(Alarm setting group)	r o P	Press  key decide ROP setting group,press  key into ACT1 setting page
5-1	ACT1(Alarm Active 1 setting page ) Default=HI	A C T 1 H I	1.Decide active 1 with  or  key(HI or LO) 2.Press  key enter data and into ACT2 setting page
5-2	ACT2(Alarm Active 2 setting page ) Default=HI	A C T 2 H I	1.Decide active 2 with  or  key(HI or LO) 2.Press  key enter data and into ACT3 setting page

5-3	ACT1(Alarm Active 3 setting page )Default=HI	ACT3 HI	1.Decide active 3 with  or  key(HI or LO) 2.Press  key enter data and into ACT4 setting page
5-4	ACT2(Alarm Active 4 setting page )Default=HI	ACT4 HI	1.Decide active 4 with  or  key(HI or LO) 2.Press  key enter data and into HYS1 setting page
5-5	HYS1(Alarm Hysteresis 1 setting page)Default=0	HYS1 0000	1.Decide Hysteresis 1 with ,  or  key(0-999) 2.Press  key enter data and into HYS2 setting page
5-6	HYS2(Alarm Hysteresis 2 setting page)Default=0	HYS2 0000	1.Decide Hysteresis 2 with ,  or  key(0-999) 2.Press  key enter data and into HYS3 setting page
5-7	HYS3(Alarm Hysteresis 3 setting page)Default=0	HYS3 0000	1.Decide Hysteresis 3 with ,  or  key(0-999) 2.Press  key enter data and into HYS4 setting page
5-8	HYS4(Alarm Hysteresis 4 setting page)Default=0	HYS4 0000	1.Decide Hysteresis 4 with ,  or  key(0-999) 2.Press  key enter data and into DEL1 setting page
5-9	DEL1(Alarm Delay 1 setting page)Default=0	DEL1 0000.0	1.Decide delay 1 with ,  or  key(0-99.9 sec) 2.Press  key enter data and into DEL2 setting page
5-10	DEL2(Alarm Delay 2 setting page)Default=0	DEL2 0000.0	1.Decide delay 2 with ,  or  key(0-99.9sec) 2.Press  key enter data and into DEL3 setting page
5-11	DEL3(Alarm Delay 3 setting page)Default=0	DEL3 0000.0	1.Decide delay 3 with ,  or  key(0-99.9 sec) 2.Press  key enter data and into DEL4 setting page
5-12	DEL4(Alarm Delay 4 setting page)Default=0	DEL4 0000.0	1.Decide delay 4 with ,  or  key(0-99.9sec) 2.Press  key enter data and into SB setting page
5-13	SB(Start band) Default=0	SB 0000	1.Decide start band with ,  or  key(-999-999) 2.Press  key enter data and into SDT setting page
5-14	SDT(Start Delay Time) Default=0	SDT 0000.0	1.Decide start delay time with ,  or  key(0-99.9sec) 2.Press  key enter data and return ROP setting group
6	AOP(Analog output setting group)	AOP	Press  key decide AOP setting group , press  key into ANLO setting page
6-1	ANLO(A/O Zero According to Display setting page)Default=0	ANLO 0000	1.Decide ANLO with ,  or  key(-19999~19999) 2.Press  key enter data and into ANHI setting page
6-2	ANHI(A/ O Span According to Display setting page)Default=0	ANHI 19999	1.Decide ANHI with ,  or  key(-19999~19999) 2.Press  key enter data and return AOP setting group
7	DOP(Communication setting group)	DOP	press  key decide DOP setting group,press  key into ADDR setting page
7-1	ADDR(Communication – Address setting page ) Default=0	ADDR 0000	1.Decide address with ,  or  key(0-255) 2.Press  key enter data and into BAUD setting page
7-2	BAUD(Communication Baud Rate setting page)Value on Default=19200	BAUD 19200	1.Decide baud rate with  or  key(19200,9600,4800,2400) 2.Press  key enter data and into PARI setting page
7-3	PARI(Communication Parity Check setting page)Default=n82	PARI n.8.2	1.Decide parity check with  or  key(n82,n81,even,odd) 2.Press  key enter data and return DOP setting group
Step	Parameter mark description	Parameter mark	Operation manual
8	Normal display	12345	Press /ALARM key about 3 sec,into AL1 setting page
8-1	AL1 (Alarm value 1 setting page) Default=0	AL1 0000	1.Decide alarm value 1 with ,  or  key(-19999-19999) 2.Press  key enter data and into AL2 setting page
8-2	AL2 (Alarm value 2 setting page) Default=0	AL2 0000	1.Decide alarm value 2 with ,  or  key(-19999-19999) 2.Press  key enter data and into AL3 setting page
8-3	AL3 (Alarm value 3 setting page) Default=0	AL3 0000	1.Decide alarm value 3 with ,  or  key(-19999-19999) 2.Press  key enter data and into AL4 setting page
8-4	AL4 (Alarm value 4 setting page) Default=0	AL4 0000	1.Decide alarm value 4 with ,  or  key(-19999-19999) 2.Press  key enter data and return normal display

Step	Parameter mark description	Parameter mark	Operation manual
9	Normal display	12345	Press  /A-ADJkey about 3 sec,into DZERO adjustment page
9-1	DZERO(Display Zero Adjust) Default=0	d P E r 0	1.Adjustment display zero with  or  key
		0 0 0 0 0	2.Press  key enter data and into DSPAN adjustment page
9-2	DSPAN(Display Span Adjust) Default=0	d S P A n	1.Adjustment display span with  or  key
		0 0 0 0 0	2.Press  key enter data and return normal display
Step	Parameter mark description	Parameter mark	Operation manual
10	Normal display	12345	Press  /A-ADJkey about 3 sec,into AZERO adjustment page
10-1	AZERO(Analog Output Zero Adjustment page) Value on EEPROM reset=0	A P E r 0	1.Adjustment analog output zero with  or  or  key( ± 9999)
		0 0 0 0 0	2.Press  key enter data and into ASPAN adjustment page
10-2	ASPAN(Analog Output Span Adjustment page) Value on EEPROM reset=0	A S P A n	1.Adjustment analog output span with  or  or  key( ± 9999)
		0 0 0 0 0	2.Press  key enter data and return normal display
Appendix	Error Mark Description	Error Mark	Analyze & Description
1	Input over error detect	1 0 F L	Input signal over range(120%)
2	Input under error detect	- 1 0 F L	Input signal under range(-20%)
3	Display over error detect	d 0 F L	Display over range(19999)
4	Display under error detect	- d 0 F L	Display under range(-19999)
5	A/D Converter error detect	A d E r	1. Input signal over range (180%) 2. Inside circuit damage Please moving input signal if still display ADER,please contact us
6	EEPROM error detect	E - 0 0	1.External interference when EEPROM read/write
		0 0	2.EEPROM write over 100 million times(guarantee 10 years)
		E E S	Please power reset,if still display E-00,doing following step: 1. E-00 & No alternate display for inquire reset EEPROM 2. Decide Yes with  or  key,press  key return normal display 3.EEPROM was reset,Please follow step 1~10 set again

## MM2 Modbus RTU Mode Protocol Address Map

Data format 16/32Bit, sign bit 8000~7FFF(-32768~32767)/80000000~7FFFFFFF(-2147483648~2147483647)

Address	Name	Description	Accept
0000	DP	DP, range 0000~0004(0~4)0:10 <sup>0</sup> ,1:10 <sup>-1</sup> ,2:10 <sup>-2</sup> ,3:10 <sup>-3</sup> ,4:10 <sup>-4</sup>	R/W
0002	DSPL	DSPL, range B1E1~4E1F(-19999~19999)	R/W
0004	DSPH	DSPH, range B1E1~4E1F(-19999~19999)	R/W
0006	AVG	AVG, range 0001~0063(1~99)	R/W
0008	LCUT	LCUT, range 0000~0063(0~99)	R/W
000A	CODE	CODE, range 0000~4E1F(0~19999)	R/W
000C	HYS1	HYS1, range 0000~03E7(0~999)	R/W
000E	HYS2	HYS2, range 0000~03E7(0~999)	R/W
0010	HYS3	HYS3, range 0000~03E7(0~999)	R/W
0012	HYS4	HYS4, range 0000~03E7(0~999)	R/W
0014	DEL1	DEL1, range 0000~03E7(0~999)	R/W
0016	DEL2	DEL2, range 0000~03E7(0~999)	R/W
0018	DEL3	DEL3, range 0000~03E7(0~999)	R/W
001A	DEL4	DEL4, range 0000~03E7(0~999)	R/W
001C	SB	SB, range FC19~03E7(-999~999)	R/W
001E	SDT	SDT, range 0000~03E7(0~999)	R/W
0020	AL1	AL1, range B1E1~4E1F(-19999~19999)	R/W
0022	AL2	AL2, range B1E1~4E1F(-19999~19999)	R/W
0024	AL3	AL3, range B1E1~4E1F(-19999~19999)	R/W
0026	AL4	AL4, range B1E1~4E1F(-19999~19999)	R/W
0028	ANLO	ANLO, range B1E1~4E1F(-19999~19999)	R/W
002A	ANHI	ANHI, range B1E1~4E1F(-19999~19999)	R/W
002C	AZERO	AZERO, range D8F1~270F(-9999~9999)	R/W
002E	ASPAN	ASPAN, range D8F1~270F(-9999~9999)	R/W
0030	ADDR	ADDR, range 0000~00FF(0~255)	R/W
0032	BAUD	BAUD, range 0000~0003(0~3)0:19200,1:9600,2:4800,3:2400	R/W
0034	PARI	PARI, range 0000~0003(0~3)0:N.8.2.,1:N.8.1.,2:EVEN,3:ODD	R/W
0036	INLO	INLO, range 029F16~4EA4A8(171798~5153960)	R/W
003A	INHI	INHI, range 029F16~4EA4A8(171798~5153960)	R/W
003E	ACT	ACT,BIT0:ACT1,BIT1:ACT2,BIT2:ACT3,BIT3:ACT4(0:HI,1:LO)	R/W
0040	STATUS	STATUS Bit0:LOCK,Bit1:AZ,Bit2:HOLD,Bit3:MAX 0:Disable 1:Enable	R
0042	AZ	AZ VALUE, range B1E1~4E1F(-19999~19999)	R
0044	HOLD	HOLD VALUE, range B1E1~4E1F(-19999~19999)	R
0046	MAX	MAX. VALUE, range B1E1~4E1F(-19999~19999)	R
0048	DISPLAY	DISPLAY, range B1E1~4E1F(-19999~19999)	R